

# Product data sheet

## M12 Molded Cable



<https://finecables.com/m12-molded-cable-c-coded/1924/>

Product description	M12 C-coding Male Angled Connector, Molded Cable, Plastic, Unshielded, Contacts: 6, IP67/IP68
Part no.	MA12MCP06RA

### Illustration



### Scale drawing

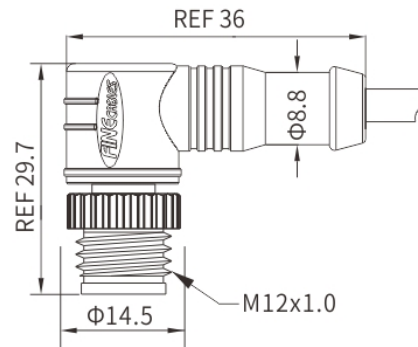

You can find the assembly instructions on the next page.

### General features

Part no.	<b>MA12MCP06RA</b>
Standard	IEC 61076-2-101
Ambient temperature	-25°C ~ +85°C (flexible installation)
Ambient temperature	-40°C ~ +85°C (fixed installation)
IP rating	IP67, IP68 in locked condition
Mating endurance	>500 cycles

### Electrical parameters

Insulation resistance	≥100MΩ
Contact resistance	≤5mΩ
Shielding	Unavailable
Rated current	2A
Rated voltage	30V AC/DC
Wire gauge	0.25mm <sup>2</sup> (AWG24)

### Material

Connector insert	TPU
Connector contacts	Brass with gold plated
Connector overmold	TPU
Coupling nut/screw	PA+GF

**Product data sheet**  
**M12 Molded Cable**



<https://finecables.com/m12-molded-cable-c-coded/1924/>

Product description	M12 C-coding Male Angled Connector, Molded Cable, Plastic, Unshielded, Contacts: 6, IP67/IP68
Part no.	MA12MCP06RA

Seal/O-ring FKM

## Security Notices

The connector must not be plugged or unplugged under load. Non-observance and improper use can result in personal injury.

The connectors have been developed for applications in plant engineering, control and electrical equipment construction. The user is responsible for checking whether the connectors can also be used in other areas of application.

Connectors which are used in circuits with voltages dangerous to the touch may only be installed and used by, or under the supervision of, persons with electrical engineering training, taking into account the applicable regulations and standards.

The user must take suitable safety precautions to ensure that the connector cannot be accidentally disconnected.

Please observe the pollution degree and the overvoltage category. For further information, please refer to the download center "Technical Information".

Finecables Enterprise Co., Ltd

Email: [info@finecables.com](mailto:info@finecables.com)

Web: [www.finecables.com](http://www.finecables.com)

Tel: +86 0769-81517898

Address: No.54 Changdi Road, Nanmian Community Humen Town Dongguan City, Guangdong Province, China.