

Junction Boxes

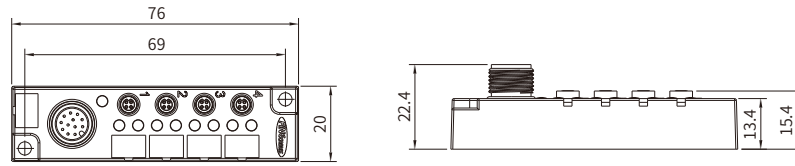

Junction Box, 4 Ports, M5 Termination, with M12 Connector



RoHS

Specifications

Contacts	M5 Pin4 (Female)	M12 Pin12 (Male)
Pin layout		
Ambient temperature	-25°C~+85°C	
Connector insert	TPU	
Connector contacts	Brass with gold plated	
Material of body	PBT	
Coupling nut/screw	Brass with nickel plated	
Body color	Blue	
Seal	FKM	
Contact resistance	≤ 3mΩ	
Rated voltage with/without LED	10~30V/120V	
Rated current	1A per signal,3A total	
LED color	Optional	
IP rating	IP 67 in locked condition	
Coding type	A-Coding	

Part Number

Pins	With LED	Without LED
4-12	JB4M5F04L-M12M12	JB4M5F04-M12M12

Circuit diagram

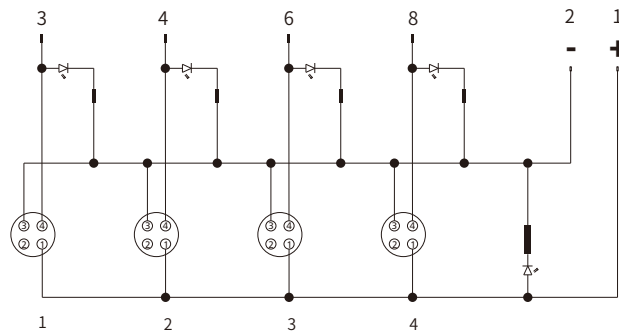

LED indicating: PNP
other circuit diagram (NPN) can be customized